



Lightcommander 12 / 2

User's Manual

**Version 1.32
June 15., 1995**

CONTENTS

Overview of Functions	5
Lightcommander 12 / 2: Functions and Controls	6
Preset Operation	8
Using Flash Buttons	8
Operating Preset-A-	8
Solo Flash	9
Operating two Presets (Presets only)	9
Selecting Preset Mode	9
Fading between Scenes	9
Channel Flash	9
Memory Operation (Preprogrammable Scenes)	10
Programming the Memory	10
Toggling from Preset Mode to Memory Mode	10
Programming Memory	10
Using Manual Masters	10
Memories	10
Selecting another Page discreetly	10
Dipless Crossfade (Insert Mode)	11
Previewing and Editing a Memory	11
Previewing a Memory store before setting up the cue	11
Editing a Memory store	11
Programming Memories blind	11
Chaser Operation	12
Programming Chaser Steps	12
Preset as Step (Level Chaser)	12
Memories as Step (Memory Chaser)	12
Chaser Type	12
The Chaser Section	12
Chaser Playback	13
Auto-Speed Chase (Run Mode)	13
Advanced Chaser Playback (Scene Playback)	14
Manual Step / GO	14
Manual Crossfade	14
Insert Mode	14
Modify Chase (Modify Chase Steps)	15
Editing Steps and Inserting Steps	15
Programming steps blind	15
Transferring a Chase to a Memory Master (CTM)	16
Programming Chase to Memory	16
Chase to Memory Playback	16
Preview Chase to Memory	16

General Functions	17
Sound to Light	17
Introduction	17
Operating Sound to Light	17
Prompt Program Change	17
Remote Step / GO	17
Switch Channels (Specials 1/2)	18
Introduction	18
Switch Position	18
Data Storage on Memory Card	18
Backup	18
Save and Load	18
Exchanging the Battery	18
Overview of Shift Functions	19
Programming Functions	19
Playback Functions:	19
Freezing the Output (Hold)	20
Live / Blind Operation	20
Theatre Mode	21
Operating 24 Channels (Wide Mode)	22
Using Upper Channels additionally	22
Setting up the 24 Channel Preset	22
Cancelling the setting (Grab Release)	22
Setting up the Output (Channel Presetting)	23
Connecting Desk Channels to DMX Channels	23
Introduction: DMX Patch	23
Connecting Desk Channels with DMX Channels	23
Indication of DMX Assignment	23
Standard Assignment	23
Settings for Analog and DMX Output	24
Disable Solo	24
Select Curve	24
MIDI Operation	24
Introduction	24
Linking two Lightcommanders	24
Recording to a Sequencer	25
Playing back a MIDI Show with Sequencer	25
MIDI Format and MIDI Commands	26
Important Button Keys	27
Delete All	27
Lock Preset Mode	27
Lock Programming	27
Blank Chaser Storage indication	27
Software Version	27

Technical Specification	29
Inputs and Outputs (Pinlayout)	29
Safety Instructions	30
Declaration of Conformity	31
INDEX	32

The following symbols are used in this manual:



Important Information! Read carefully.



Here, a function will be explained more detailed.



Hints give a suggestion how to proceed.



This asks you to push a button.

Overview of Functions

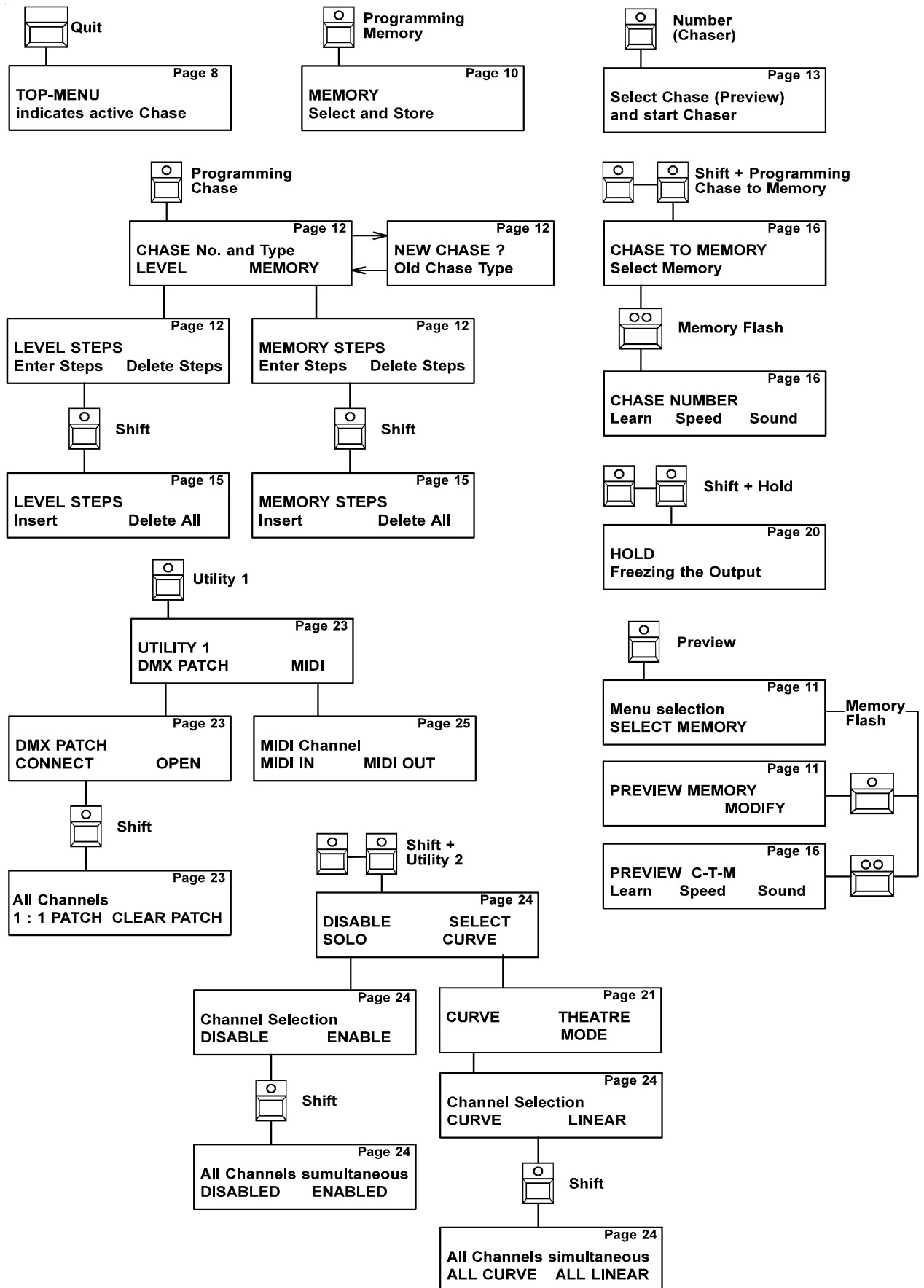

Lightcommander 12 / 2: Functions and Controls

1. **Power Switch**
2. **XLR Socket**
Connector for a gooseneck lamp (Pinlayout see technical specification).
3. **Sound control and Switched Channels**
4. **The Display Section**
General playback and programming functions are located there.
5. **Channel Faders on PRESET -A- (-A- Preset).**
Master -A- sets maximum output level for all preset channels. Memories and Chase steps are programmed by using Preset-A-.
6. **Memory Controls; -B- MEMORY**
Master -B- sets maximum output level of all Memory masters. All -B- Memory masters are allowed to be switched to Preset-B-Controls. (See page 9; Presets only operation)
7. **Flash Buttons (Channel Flash, Memory Flash, Solo)**
While pressed, the buttons create different flash effects (Flash Light). The flash function toggles between Channel flash and Memory flash. Within both modes, a Solo flash may be performed (sudden change).
8. **Programming Buttons (Memories, Chasers and Utilities)**
You may program 120 Real Level Memories and up to 9000 Chase steps. The Utility menus guide you through the output setups. (Presettings, such as DMX-Patch).

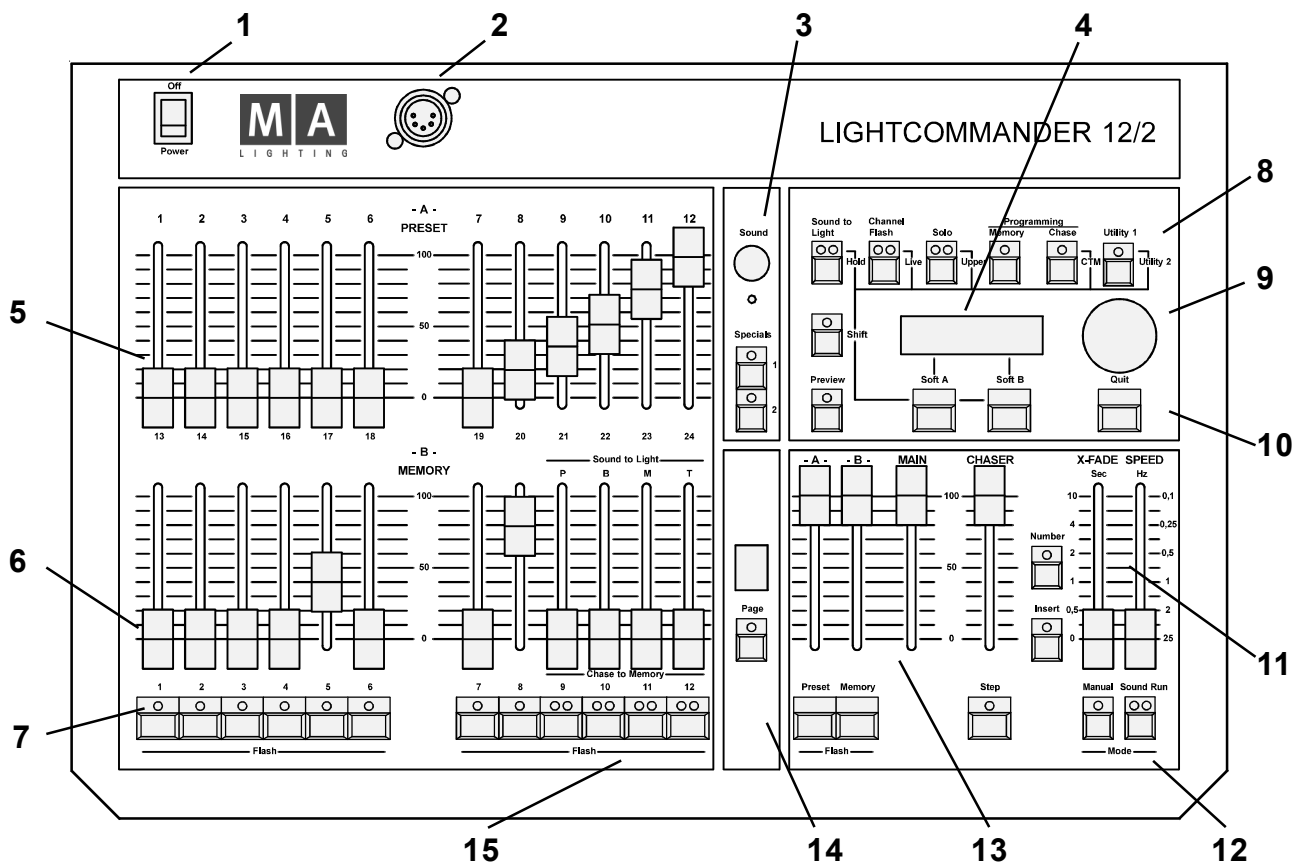

9. The Encoder wheel

Selections e.g. Chaser programs or settings of menu modifiers are performed via the big wheel above the Quit button.

10. Soft Buttons and Quit

Both soft buttons are selecting displayed functions.

Quit cancels each function and switches back to Top-Menu.

11. The Chaser Section

Chase steps may run as Auto-Steps (Speed), Sound-Steps (Sound In), or Manual-Steps (Step Button / Manual X Fade).

12. Chaser Mode Buttons

You may preselect how a Chase step will be performed.

13. The Master Section

Preset-A-Master sets maximum output level for all **Preset-A-Channels**.

(Preset -B-) Memory-B-Master sets max. output level for Memory masters.

MAIN Master sets maximum output level for the entire desk.

Chaser Master sets maximum output level for Chase steps.

14. Page Button

12 Memory cues are available within each of 10 pages (Page 0-9).

15. Sound to Light / Chase to Memory

Sound and Chaser effects are controlled in this section.

A detailed description follows later in this manual.

About this manual

TOP MENU

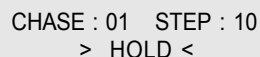

```
CHASE : 01  STEP : 10
> HOLD <
```

→ **TOP-MENU:** Appears after switching on the desk.

- The preselected Chaser program is on display.
- In the lower line HOLD, LIVE and UPPER are indicated to be active, if selected.

Notes:

- We reserve the right to alter functions without prior notice.
 - The Lightcommander is designed for use as a lighting control desk only.
 - All described playback functions can be used together and offer high demanding possibilities in lighting design.
 - First, familiarize yourself with a function, then go on.
-

Preset Operation

Flash button operation
Preset operation
Using Presets only
Fading between Scenes
Channel Flash
Solo Flash

Main Master sets maximum level of Flash buttons.

While programming, the Flash buttons select a channel or a Memory number.

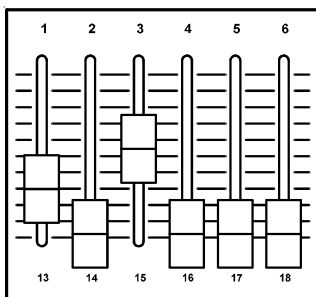

Using Flash Buttons

Memory Flash and Solo:

While pressed, individual Memories are added to the current output. When **SOLO** is selected, Memory flash swaps the output to the selected Memory.

Channel Flash and Solo:

If Channel flash is preselected, flash adds individual channels to the output. When **SOLO** is selected, Channel flash swaps the output to the actual flashed channel, only.

Master-A-Flash sets Preset-A- to the level of the Main master.

Master-B-Flash sets all Memory masters to the level of the Main master.

Operating Preset-A-

- Set **Main Master** and **Preset-A-Master** to full.
- Adjust individual channels on the preset.
- ➔ You can see the output level on stage;
The LED's indicate the brightness of the channels.
- You may fade-in and fade-out a scene, using the Preset-A-Master, or just prepare a new scene and than fade-in.
- Now test the **Channel Flash** and **Solo Flash** functions.

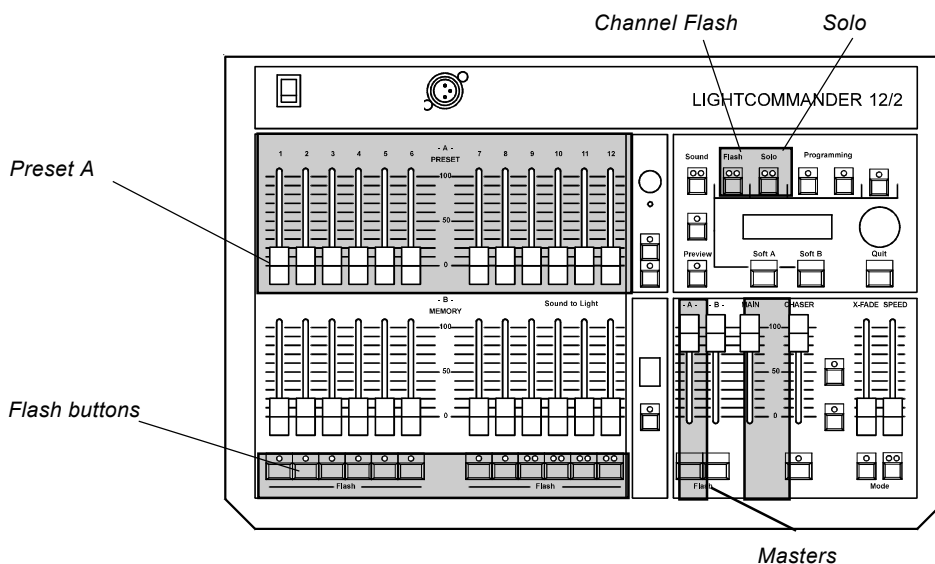

Operating two Presets (Presets only)

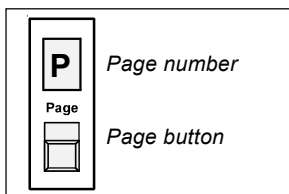

Selecting Preset Mode

- Hold the **Page** button and select **-P-** using the Encoder wheel (the display flashes).
- ➔ **Preset mode** will be auto-selected after 3 seconds.
- ➔ Programming memory is disabled. The Chaser section remains fully functional.

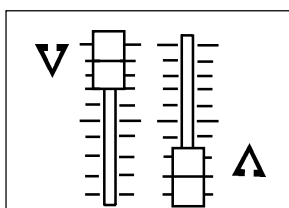

Fading between Scenes

- Set Main master and Master **-A-** to full (set Master **-B-** to zero).
- Adjust a scene on Preset **-A-** and on Preset **-B-**.
- ➔ Fade between **Master -A-** and **Master -B-** (manual Fade).
- ➔ Note: With Preset mode selected, the **-B- Memory** faders are named as **Preset -B-**.

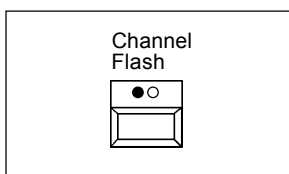

Channel Flash

- ➔ In Preset mode, the Channel flash function is auto-selected.
- Use the **Flash** buttons. The Channel or the entire Preset appears at the output, even if Master **-A-** and **-B-** are set to zero.

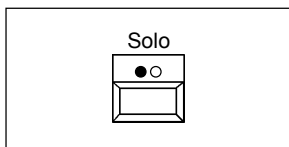

Solo Flash

- Select **Solo** and bump **Flash** buttons:
- ➔ *Only the selected Channel* appears at the output. (As long as the button is held down, other channels go off).

➔ You may also use the **Autofade Function** with Presets. Further details see page 11, "Dipless Crossfade" and page 13, "The Insert Mode".

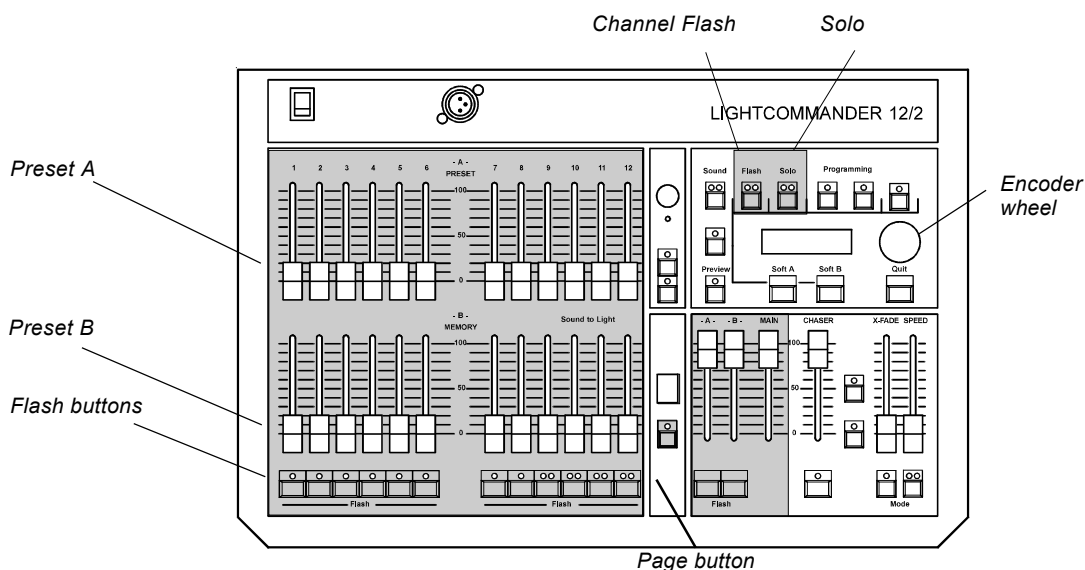

Memory Operation (Preprogrammable Scenes)

Programming Memories
Memory Playback and Insert Crossfade
Preview Memory (Modify Memory)
Blind Programming

Note: You may use the page button, to skip from page to page (Page up).
Use Shift+Page to select page down.

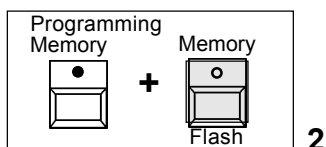

SEL. MEMORY O8/5
PRESET < SAVE > ALL

Programming the Memory

Toggleing from Preset Mode to Memory Mode

- Hold **Page** and select a new Page, using the **Encoder wheel**, e.g. **Page-1-**.
- Wait 3 seconds. Hence, Memory mode is selected.
- ➔ The Page button LED flashes until all Memory faders are set to zero.
- ➔ **Flash buttons** and **Solo flash** function now as **Memory flash**.

Programming Memory

- Select **Programming Memory**.
The Preset scene is indicated by the LED's, in spite of all Masters being set to zero.
- Use a Flash button to select a **Memory**; if required you may select another **Page**.
- Adjust a scene on Preset-A-.
- ➔ Press the Soft key **SAVE PRESET** to store the preset levels into the Memory.
- **SAVE All** stores the actual output.
(Everything visible on stage, including Chaser steps).
- Press **Quit** to return to the Top-Menu. Ready!

Using Manual Masters

Memories

- Set **Main** master and **Master -B-** to full (Preset set to zero).
- Push up a manual **Memory** master.
- ➔ The **Memory** appears to be on stage.

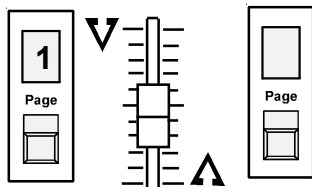

Selecting another Page discreetly

- Push up some manual masters and select a new Page.
- ➔ The Memory remains on that page it has been set up from, until the fader is set to zero.
- Note: Meanwhile other Memories may be set up from the new **Page**.



Practice using the above functions before going on to the next section.

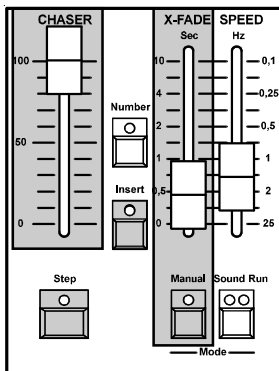

Dipless Crossfade (Insert Mode)

Memory X-Fade by using Flash buttons:

- Switch off **Channel Flash**, to release the flash buttons.
- Set up **Chaser Master** and select **Insert** within the Chaser section. (If a Chaser is running, it stops at the actual step))
- Use the **X-Fader** to set the required **Fade time**. Press a **Memory flash button**.
 - ➔ The memory fades in at the set time.
- ➔ Each other selected Memory will initiate a Crossfade from one into the next Memory, in order of selection.
- ➔ Use the **Step button**, to achieve a fade between the actual and the previous Memory.
- ➔ Switching **Insert OFF**, causes the Chaser to **continue**.
 Note: **Chaser Master** sets maximum **output level** of Insert Steps.

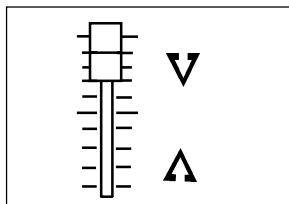

Manual Memory Crossfade:

- Turn on **Insert** and **Manual**.
- Move the **X-Fader** from end to end. After fading in a memory (i.e. fader full up or full down), select the next to be faded.
- If you don't select a Memory, the previous one is faded in and you can change between both. The Chaser Master controls brightness.

Fading out Memories:

- Turn **Insert** off and press the **Step button**, or use the **X-Fader** to fade down.
 (This depends on the kind of Insert mode, you have selected).
- Note: If a Chaser was preselected, a Step will be faded in.

Inserting Preset A

- ➔ Use the **Master-A- Flash button** to insert the actual scene from **Preset-A-**.

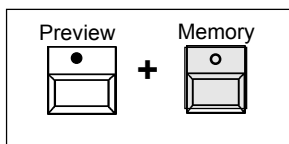

Previewing and Editing a Memory

Previewing a Memory store before setting up the cue

- Turn **Preview** on and select a Memory with the Flash buttons.
- ➔ The Memory store is indicated on the LED's. Preview automatically turns Live mode *off* (if selected). The consoles output will not be affected.

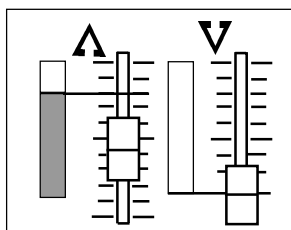

Editing a Memory store

- ➔ *While* previewing, select **Modify** out of the displayed menu.
- Use the **Channel fader** to "grab" the preprogrammed level.
- ➔ Modify as required and save using **Quit**. Ready!
 The output will not be affected by this.

Programming Memories blind

- Turn Live off if it is selected, using the Shift+Live buttons.
 - Set **Master-A-** to zero and program as usual.
 - ➔ The setting on Preset A will not affect the output.
- NOTE: When the desk is switched to **LIVE** while editing a Memory this Memory appears at the output.

Chaser Operation

Chaser Programming	
Chaser Playback	
Modify Chaser	(Edit and insert steps)
Blind Programming	
Chase to Memory	(Transferring a Chase to a Manual Master)
Preview Chase to Memory (Modify)	

Programming Chaser Steps

Preset as Step (Level Chaser)

CHASE NO. 10 (00)
■LEVEL■ MEMORY

STEP: 01
ENTER DELETE

FADETIME: 0.00S
CONT



- Press **Chase** Programming and select a **Chaser program number** with the **Encoder wheel**, e.g. **No. 10**.
- Press **■LEVEL■** to proceed with Level Chase Programming.
 - ➔ Channel levels appear on the LED's (master independent).
- Adjust channels to prepare for a step and save with **ENTER**. (In Blind mode only Preset levels are stored).
- In the following menu the desired FADE time is set. This time is only relevant while the THEATRE MODE is active (see p. 21). The value for new steps is 0.00 seconds. Confirming this value by **CONT**.
 - **DELETE** removes one Chase Step.
- Turn the Encoder wheel and see the steps appearing on the LED's.
- Use **Shift+Live** buttons. The steps appears at the output.
 - ➔ Programming in **Live Mode** enables the entire output to be recorded as a step (Preset and Memories etc.).
- With **Quit** the desk returns to **Top-Menu**.

Memories as Step (Memory Chaser)

STEP: 01 MEM: 11/5
ENTER DELETE

FADETIME: 0.00S
CONT

- Press **Chase** Programming and turn the Encoder wheel to select a Chaser Program Number e.g. **No. 05**.
- Press **MEMORY** and select a memory with **Memory Flash** buttons.
 - ➔ Press **ENTER** to record this Memory as a step;
- In the following menu the desired FADE time is set. This time is only relevant while the THEATRE MODE is active (see p. 21). The value for new steps is 0.00 seconds. Confirming this value by **CONT**.
 - ➔ Turn the Encoder wheel to view the steps appearing on the LED's.
 - **DELETE** removes one Memory step.
- While **Shift+Live** is selected, you can view steps on **Stage**.

Chaser Type

- ➔ **■LEVEL■** or **■MEMORY■** show which Chaser type has been programmed within the selected number.
- Press the unmarked Soft Key:
A menu asks: **NEW CHASER?**
- ➔ If **YES** is selected, the entire Chaser will be deleted!



Dipless Crossfade
Theatre Mode

p. 11
p. 21

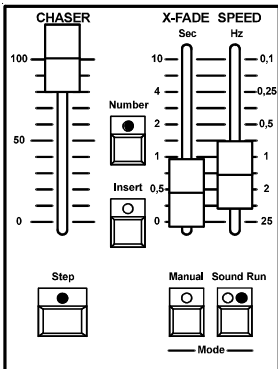

The Chaser Section

→ **Number:** Selection and Preview Chaser (hold button).
 → **Note:** A Chaser with at least one step, will cause the LED to light, if the Chaser Master is set above 5% level.

Step: LED flashes according to the trigger (Step, Speed, Sound).

Run Mode: The drawing shows Standard Settings: Brightness, Fade and Speed are set individually.

Sound Mode: Bass Step Chase.

Manual Mode: Manual Fade between Steps.

Insert: Crossfade between Steps and Insert Memories achievable.

Chaser Playback

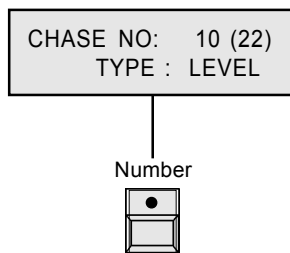

*Hold button: Previews Chaser
 Release button: Starts Chaser*

*Shift + Number starts
 previous Chaser program.*

Auto-Speed Chase (Run Mode)

- Turn Insert and Manual **OFF**.
- Select **Run** (briefly press **Sound / Run** button two times). The Step button LED flashes with preset Speed.
- Set up **Chaser Master** and set **Speed** with Speed fader. If required, set **X-Fade time** with the Crossfader.
- Press and hold **Number** and select a Chaser program, e.g. Chaser **No. 10**.
- **Auto Preview:** The Chaser is indicated on the LED's. The output will not be affected.
- To **START** and output the Chaser, release button.
- To **Restart** the Chaser, briefly hit the **Number** button.
- **Stopping a Chase:**
 1. Set **Chaser Master** to zero (Chaser continues), or....
 2. **Start** a Chase without programmed Steps (idling Chaser). (Chaser stops; Number LED remain off).
- Select **Sound Mode** to achieve a **Bass Step Chase** (Sound In).

Advanced Chaser Playback (Scene Playback)

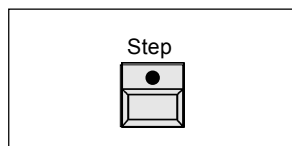

Manual Step / GO

- Turn **RUN OFF** and press **Step (GO)** to recall steps.
 - Steps are fading in with preselected X-Fade time or (using Theatre Mode) with the stored time for this step.
- Turn **RUN ON** again: Chase is continued automatically.

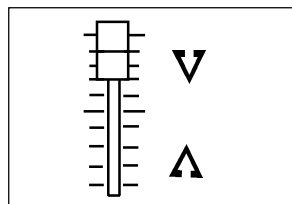

Manual Crossfade

- Turn **Manual** on and see the Chaser to be stopped.
 - ➔ Push **X-Fader** from end to end.
- Steps appear in the preprogrammed order.
- ➔ **STOPPING** a manual Chase:
 1. Set **Chaser Master** to **zero** (Fade remains active), or....
 2. Use **Number** to start a Chaser without preprogrammed Steps.
 - ➔ Being in manual Playback, you have to fade out Steps manually, also.
(Use Step button or manual X-Fader).

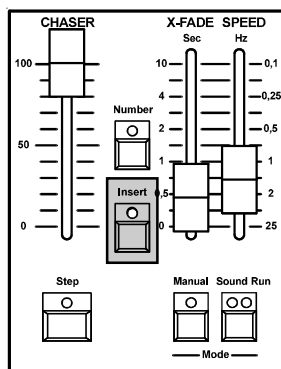

Insert Mode

Changing Steps, Memories and Preset-A-:

- Turn **Insert** on and press **Step**, or.....
use the X-Fader, if Manual is selected.
- The previous Step is fading in (Insert Step).
If a Memory is selected, the Fade toggles between fading in the memory and then the step, again.
- ➔ Note: **Master-A-Flash** enables the entire **Preset** to be inserted.

Inserting Memories

- ➔ Repeat steps as described in chapter "Dipless Crossfade".
(See Page 11)

Modify Chase (Modify Chase Steps)

Editing Steps and Inserting Steps

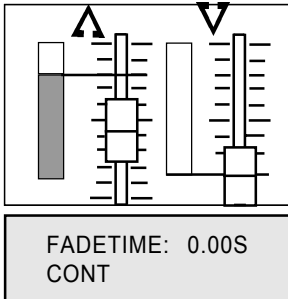

Editing Level Steps (Menu Level Step Programming)

- Use the Encoder wheel, to **Choose** a Step to be modified. The stored levels are indicated on the LED's.
- ➔ **Modifying a Channel:** Use Channel Fader to "grab" the actual level and alter as required. You may add channels, also.
- ➔ **ENTER** stores every alteration.
- In the following menu the desired FADE time is set. This time is only relevant while the THEATRE MODE is active (see p. 21). The value for new steps is 0.00 seconds. Confirming this value by CONT.

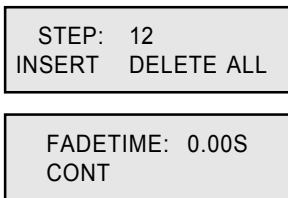

Inserting Level Steps (Menu Level Step Programming)

- Press **Shift** to proceed to a further menu.
- Adjust the step to be inserted on Preset-A-.
- ➔ **INSERT** adds the step to the existing Chaser. The step is inserted in front of the actual selected one.
- In the following menu the desired FADE time is set. This time is only relevant while the THEATRE MODE is active (see p. 21). The value for new steps is 0.00 seconds. Confirming this value by CONT.
- **DELETE ALL** removes all steps.
- ➔ **Take care with this function:** The entire Chaser with all step will be deleted!!!

Editing Memory Steps (Menu Memory Step Programming)

A memory has to be modified, using **Preview Memory**. See page 11, "Editing a Memory store".

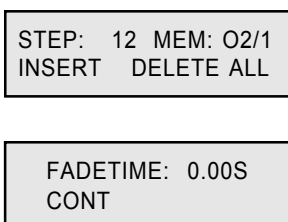

Inserting Memory Steps (Menu Memory Step Programming)

- Press **Shift** to proceed to another menu, hence select the memory to be inserted, using the Flash buttons.
- ➔ **INSERT** adds this memory to the existing Chaser. The step is inserted in front of the actual selected one.
- In the following menu the desired FADE time is set. This time is only relevant while the THEATRE MODE is active (see p. 21). The value for new steps is 0.00 seconds. Confirming this value by CONT.
- **DELETE ALL** removes all steps.
- ➔ **Take care with this function:** The entire Chaser with all steps will be deleted!!!

Programming steps blind

- Turn Live **OFF** if it is selected, using the **Shift+Live** buttons.
- ➔ Set **Master-A-** to zero and program as usual (Level Step). NOTE: While programming memory steps, there is no need to set Master-A- to zero. The desk's output will not be affected!



Advanced Chaser Operation:

CHASE TO MEMORY
> SELECT MEMORY <

10/6 CHASE: 10
LEARN 1.00S BASS

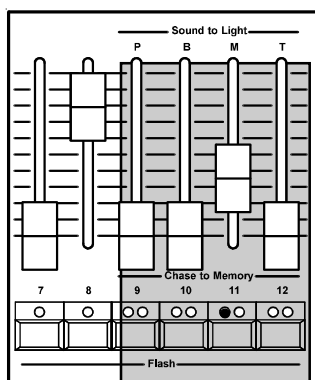

Transferring a Chase to a Memory Master (CTM)

Programming Chase to Memory

- Use **Shift + CTM** buttons and select a **Memory** (Flash button with red and yellow LED's)
- Use **Encoder wheel** to select a **Chaser program**.
 - ➔ The Chaser appears to be indicated on LED's: Watch this **Auto Preview**, to ensure the right Chase selection.
 - ➔ Auto Preview will not affect the output.
- Set **Speed**, using **LEARN** to step ahead at the required rate, or, hold down LEARN and adjust speed via Encoder wheel.
- ➔ Press **Quit** to store setup. The yellow LED flashes according to the preset rate. (If Sound is selected, according to Bass Rhythm).

Chase to Memory Playback

- Push up the assigned **Memory Master** to fade in the Chaser. You may use the **Flash button**, if Channel Flash and Insert Mode are selected to be OFF.
- ➔ Pushing Flash, or setting up the fader from zero, will cause a **Restart** of the Chaser in the Memory.
- ➔ On each page, 4 Chases with different speeds may be programmed. Including a Chase in the Chaser section, altogether five Chasers are allowed to be run simultaneously.

10/ 2 NO O2 0.25S
LEARN BASS

Preview Chase to Memory

- Turn **Preview** on and press **Memory Flash Button**. The Chaser appears on the LED's.
- **Speed** may now be set *directly* via the Encoder wheel. (Single handed operation).



Note: If Shift+Live buttons are used, the chaser appears at the output.

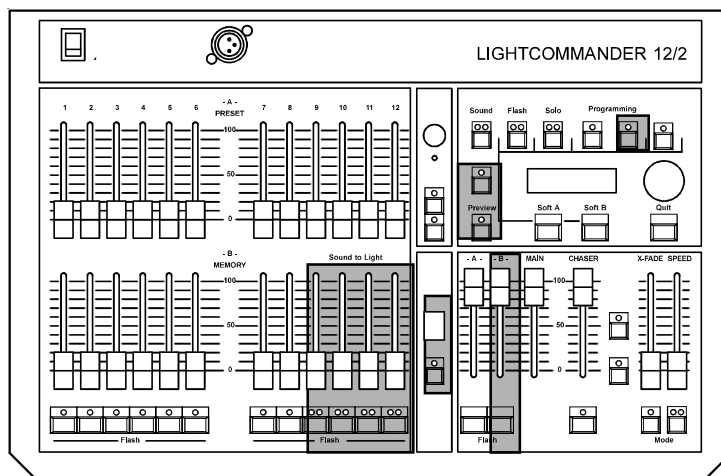

General Functions

Sound to Light	
Remote Step	
Switch Channels	(Specials)
Store Programs to Card	(Backup)
Overview of Shift Operation	
Freeze Output	(Hold)
Live / Blind Operation	
24 Channel Operation	(Upper Channels)
Theatre Mode	

Sound to Light

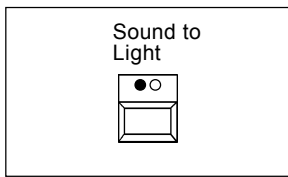

Introduction

- Within the Sound to Light mode, the levels of Memories 9-12 are controlled by the audio input (Sound In). Signal input will be split into three frequency ranges;
- **-B-** ; **-M-** ; **-T-** ; **Bass, Mid** and **Treble** are controlling the associated Memories, depending on input volume.
- **-P- = Pause**; this Memory is inverse proportional to input volume. (I.e. audio off causes the memory to be on)
- ➔ The Memory Masters set maximum output of audio triggered Cues. (100% when set to mid position)

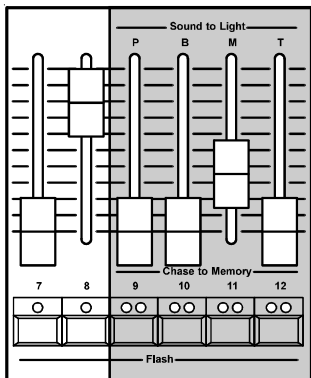

Operating Sound to Light

- Feed **Sound IN** socket with an audio input.
- Turn **Sound control** up, until the **LED** flashes with Bass Rhythm.
- ➔ Turn **Sound to Light** on and set the four Sound to Light Memories to neutral position.
- Observe playback and readjust brightness, if required.

Prompt Program Change

- Press **Page** briefly.
- ➔ This four Memories achieve a sudden change of page. (There is no need to set Faders to zero, beforehand)

Remote Step / GO

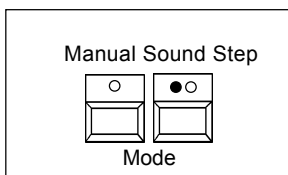

- Use Number to load a Chase into the Chaser (RUN OFF).
- Insert a **Foot switch** into the **Remote Step** input.
- ➔ The Chaser jumps one step ahead, each time the contact is closed. Simultaneous Sound Steps possible. (Compare with page 13, "Chaser Playback").

Switch Channels (Specials 1/2)

Introduction

- **Specials 1 and 2** are two additional channels. They are operated independently of the desk and wired directly to the analog output. (Can be patched, using DMX. See page 23, "DMX-Patch")

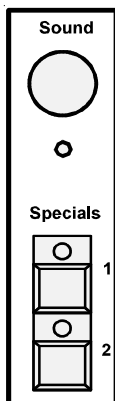

Switch Position

- **OFF** or full **ON** (Analog output: 0/+10 VDC).
 → With both **Analog Outputs**, Fog Machines or other effects with 0 10 Volts Operation may be controlled *directly*.
 → **Attention:** You can only control equipment that has no voltage at its input (**in no case 230 V**).

Data Storage on Memory Card

Backup

- Using a Memory Card enables you, to create a personal library of lighting plots. Different programs can be easily loaded into the desk.
- A backup is also a security copy of your work. Accidentally deleted programs can be retrieved easily by loading the backup from card.

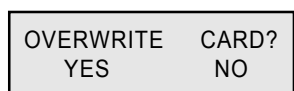
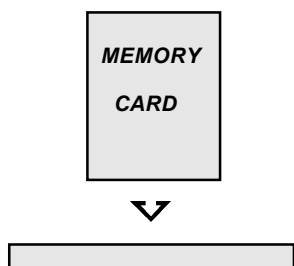

Save and Load

- Put the **Memory Card** into the slot, located above the Programming buttons. Follow the instructions in the display.

Exchanging the Battery

- Renew battery, if the display shows a voltage below 2.3 V. (or after approx. 2 years, at the latest).
 → Load the program from card into the desk, exchange battery, and save to card again.



Overview of Shift Functions

Playback Functions:

Note: As long as "Shift" is held, each Shift Function may be selected one after another.

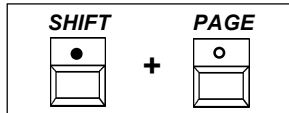

→ Counts one page backwards (Page down).

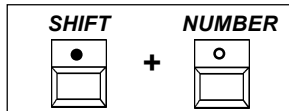

→ Starts the previous run Chaser.

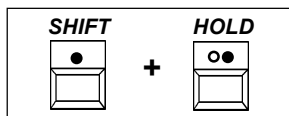

→ Freezing the desk's output.

- New settings do not affect the output. A detailed description follows later in this chapter.

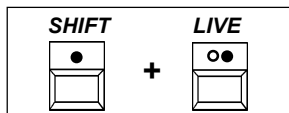

→ Activates Live Operation.

- Programmed storage is output onto stage. A detailed description follows later in this chapter.

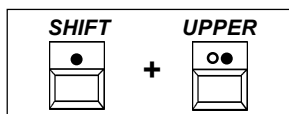

→ Swaps Channels 1-12 with Channels 13-24.

- Setting up scenes with 24 channels by toggling between Upper and standard. Modifying channels by "grabbing" the actual level.

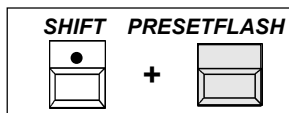

- Cancelling a setting: Using **Shift+Preset Flash** sets all levels to zero. Quit sets levels to the actual fader setting. A detailed description follows later in this chapter.

Programming Functions

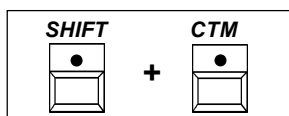

→ Menu: Programming Chase to Memory

A detailed description will be found on page 16. (Chase to Memory Master transfer)



→ Menus: Programming Chaser Steps

- A further menu appears; Steps may be inserted, or the entire Chaser may be deleted (see page 15).

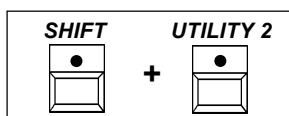

→ Activating the THEATRE MODE see page 21

→ Special Menus to adjust output channels. For a detailed description see page 22: "Setting up Output Channels"

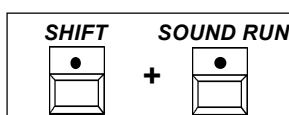

→ Switching the desk from SOUND to MANUAL

Function analogue to SOUND/RUN, but the other way round

Shift Operation while Playback:

Output Freeze Function	(Hold)
Live / Blind Operation; the difference	(Live / Blind Operation)
Wide Mode; 24 Channel Operation	(Upper Channels)

Freezing the Output (Hold)

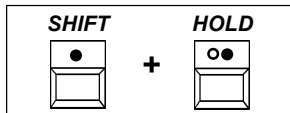

SET MAIN TO ZERO
CANCEL

You want to set up an entirely different setting on desk, discretely?

- Press **Shift + Hold** buttons.
- ➔ The desk's output is frozen, now. Any action will not affect outputs. You may prepare each new setting, discretely.
- **Sudden Release:** Press **CANCEL** to skip to the new setting.
- **Crossfading** to a new setting: Set **Main Master** to **Zero** and push it back to **Full** again.
- ➔ **Hold** is auto-released, when Main is set to full.

Live / Blind Operation

BLIND:

- **NOTE: Blind is the Standard setting.**
- ➔ Previewed Memories, auto-previewed Chases and Chases being selected while programming, will be indicated **ON LED's exclusively**.
- This enables **discrete Editing** and Modifying, even during the show takes place, without any affect on the outputs.

LIVE:

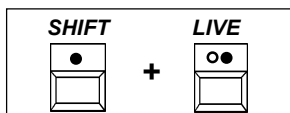

- ➔ Previewed Memories, auto-previewed Chases and Chases being selected while programming, will appear **ON STAGE**.
- Note:** Only the selected program remains visible, if the Main Master is set to zero.

- ➔ **Note: Preview auto selects Blind Operation.**
Turn on Live afterward selecting preview to see the memory store live on stage.

Overview:

Shift Functions while Playback.

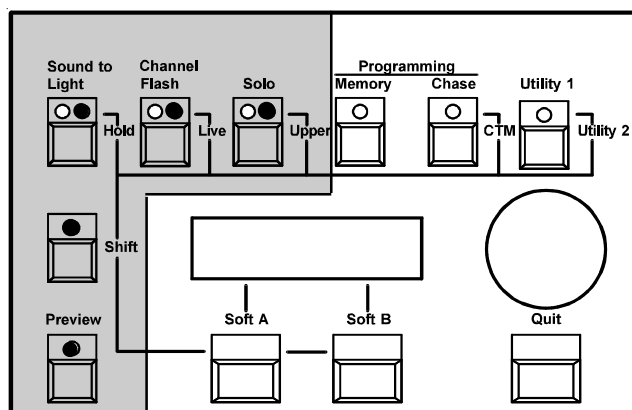

THEATRE MODE

From version 1.26 there is one new mode in the Lightcommander 12/2 for programming a chaser. It is now possible to assign a special fadetime to every single chaser step. This mode is called THEATRE MODE.

Conditions for the THEATRE MODE



- The chaser may not run by sound or automatically
- Manual fading must be off
- The INSERT mode must be inactive
- The THEATRE mode must be activated (see below)

Programming the fadetimes

FADETIME: 0.00S
CONT

- After saving one step by ENTER (see user's manual p. 12 and 14) appears this menu
- While editing of programmed steps the corresponding time will be shown instead of 0.00
- By turning the encoder the value can be changed between 0.00 and 10.0 seconds
- Storing the value by the CONT button
- Then the next step can be programmed or edited
- The fadetimes are part of the chaser and will be saved also to the memory card.

Activating the THEATRE MODE

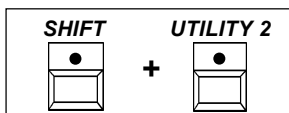

- **SHIFT +UTILITY"** and within the next menu **MORE** leds you to the THEATRE MODE
- By pressing the button THEATRE MODE this mode will be activated (stripebefore the word "MODE" indicates mode ON)
- While the THEATRE mode is active, there is a vertical line within the squares of the lower row in the main menu



Even if the THEATRE MODE is activated as described above, any changes made will not take effect until all conditions described in section 1 are met!

Working in the THEATRE MODE

- As soon as all mentioned conditions are fulfilled, for the NEXT step the times saved according to 2. are relevant; the times adjusted by the XFADE fader are invalid.
- By moving the XFADE fader changing of the actual fade time is possible. The fader will be fixed at the given value (grab, analogue to editing of memories).
- After inactivating the THEATRE mode by the criterion mentioned above the actual fade will be finished using the value set by the XFADE fader.

Operating 24 Channels (Wide Mode)

Using Upper Channels additionally

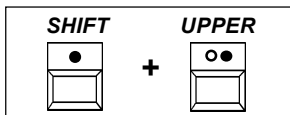

- The Lightcommander deals with 24 channels permanent.
- Using **Shift + Upper** buttons activates channels 13-24.
- Each Setting, Programming or Selecting function now relates to channels 13-24, including Flash functions.
 - You may program or modify memories or Level chase steps, containing a selection out of 24 channels.
- Flash buttons function the same in standard mode as in upper mode (e.g. selecting channels while using DMX-Patch. See facing page).

Setting up the 24 Channel Preset

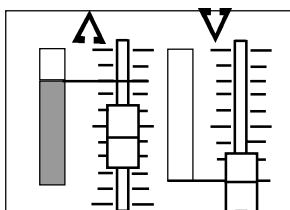

- Adjust a selection out of channels 1-12 as required.
- Use **Shift + Upper** to access the channels 13-24.
- "Grab" the actual indicated level (If zero, just push up the fader) and set channel levels as required.
- Modifying a channel later is performed in the same manner. Set the **Channel Fader** to the indicated output level to "grab" the level to be modified and readjust brightness as required.

Cancelling the setting (Grab Release)

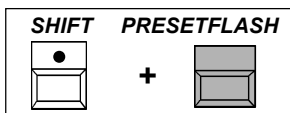

- Using **Shift + Preset Flash** sets every level of all preset Channels to zero.
- You may "grab" channels at zero individually to adjust a new setting. Another way is to **cancel** all auto-functions while pressing **Quit**. The levels skip back to the actual **Fader Position**.

UPPER CHANNELS

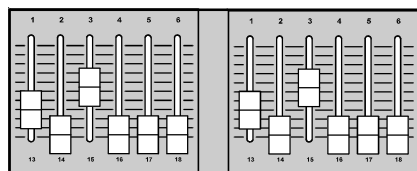

The desk simulates 12 further Channel faders and Flash buttons to select channels.

Flash buttons are toggled else!

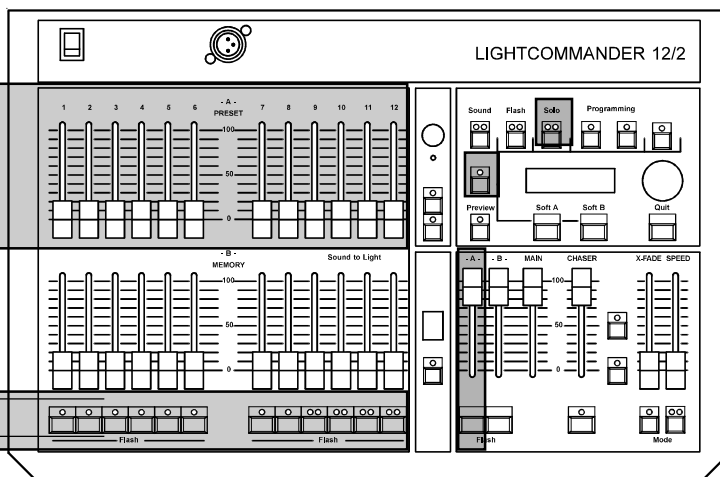

Setting up the Output (Channel Presetting)

- How to connect desk channels with DMX channels (DMX Patch)
- How to prevent channels to be dimmed by Solo (Disable Solo)
- How to match dimming levels of different lamps (Select Curve)

Connecting Desk Channels to DMX Channels

Introduction: DMX Patch

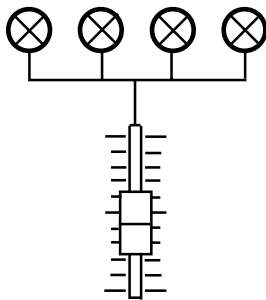

- **DMX Patch** will not affect the analog output!
The DMX output controls the DMX channels 1-99.
DMX Patch enables the connection of each desk channel with up to four DMX channels.
This function may be especially interesting when dealing with different stages, when using motorized equipment and colour changers and also in case of Dimmer failure.
Within Standard Assignment the Desk Channels 1-26 are connected to the DMX Channels 1-26 (other channels are open).

Connecting Desk Channels with DMX Channels

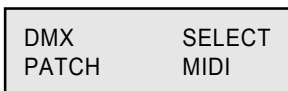

- Press **Utility 1** and select **DMX PATCH**.
- Use **Flash** button to select a **Desk Channel** and turn Encoder wheel to select a **DMX Channel**.
- You can view the selected **DMX Channel** appearing at the output, by switching the desk to **Live Operation** (Shift+Live).
- To assign channels press **CONNECT**.
- **CONNECT** shows the channels which are connected.
You may verify this, by pushing up the associated channel fader.

Indication of DMX Assignment

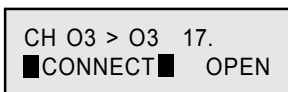

- **CONNECT** **Actual** display; this DMX channel is connected to the indicated Desk channel.
- **CONNECT:** This DMX channel is connected to another Desk channel.
- **OPEN** This DMX channel is **NOT** connected.

Standard Assignment

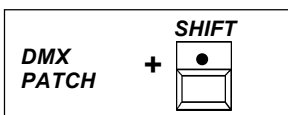

- **Shift** proceeds to another menu:
ALL 1 : 1: Desk channels 1-26 control DMX channels 1-26.
- **ALL CLEAR opens each connection!**
- Use this function only if a new patch setting is required, or save the actual setting to card, before continuing.

Settings for Analog and DMX Output

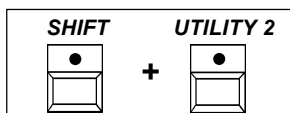

Disable Solo

You want appointed channels to remain on, while using Solo Flash?

- Press **Shift + Utility 2** and select **DISABLE SOLO** from the menu.
- Select **Channels** with **Flash Buttons** or with **Encoder wheel** and set as required (Standard: All Enabled).
- ➔ A channel indicated as **DISABLED** remains on while using Solo Flash.
There is no difference between Memory Solo or Channel Solo.

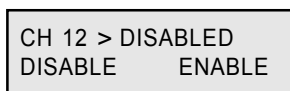

- ➔ **Shift** proceeds to a further Menu.
ALL DISABLED or **ALL ENABLED** swaps function of all channels simultaneously.
-

Select Curve

While using projectors with different lamp bulbs, it may occur, that brightness differs, although faders are set to the same level. You may get a similar effect, if you operate dimmers from different manufacturers, or with differing technology.

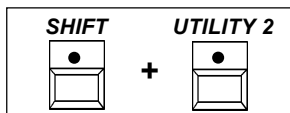

- ➔ Match this by setting the darker channels to **Curve**. (Increases the lower setting range).
- Press **Shift + Utility 2** and press **SELECT CURVE** as indicated on display.
- Select channels by flash buttons or Encoder wheel and toggle them to **CURVE** if required (Standard: All Linear).

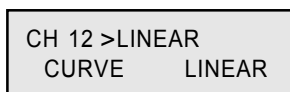

- ➔ **Shift** proceeds to a further Menu.
ALL CURVE or **ALL LINEAR** swaps function of all channels simultaneous.
-

Note: This function has no influence on brightness of LED's.

MIDI Operation

Introduction

MIDI enables you to link several Lightcommanders, by connecting the MIDI OUT Socket of a desk to the MIDI IN socket of another desk. By means of this, Memories with Page and Chaser Programs with mode (Manual Step, Sound Step, or Speed) are transferred.

While programming linked desks, you have to prepare settings on each desk simultaneously.

Other Operations:

An entire show can be recorded to a sequencer, using MIDI OUT.

Later, this show can be played back from sequencer, using MIDI IN.

Linking two Lightcommanders



- Set all **Masters** to zero.
 - Connect MIDI OUT of the main desk with MIDI IN of another desk.
 - Press **Utility 1** buttons and **SELECT MIDI** function in the display.
 - Select same **MIDI Channel** on both desks and select **MIDI IN** on the receiver desk **FIRST**.
HENCE, turn **MIDI OUT** on at the main desk!
→ The sign MIDI appears in the Top Menu to indicate mode of operation.
 - Push up the Main Master at the receiver desk and set Masters of main desk as required.
The maximum output level of the receiver desk is set by its own Main Master, other masters are controlled by the main desk.
→ After the desks have been programmed simultaneously, **Memories and Chasers** can be played back by the main desk **controls**.
-

Recording to a Sequencer



- Connect **MIDI OUT** to the MIDI input of the sequencer.
 - Press **Utility 1** and **SELECT MIDI**.
Set same **MIDI Channel** for both, Lightcommander and sequencer.
→ **First**, start the Sequencer ("Record").
 - Turn **MIDI OUT** on at the Lightcommander.
→ The Sequencer is recording **Memory** and **Chaser** playbacks.
(Individual channels will not be recorded)
-

Playing back a MIDI Show with Sequencer

- Connect MIDI IN of the Lightcommander to the Sequencer output.
 - Select **MIDI Channel** and turn **MIDI IN** on.
→ Start the Sequencer.
The earlier recorded Show will be played back automatically.
The show can be synchronized with other MIDI Equipment.
-

- On the following page you will find detailed informations about the MIDI Format and the transferred commands.
-

MIDI Format and MIDI Commands



- MIDI exclusively deals with Controller Commands. In the MIDI menu two different sets of controller commands can be activated. Press Shift button within the MIDI menu.
 - While MIDI OUT is turned on, all fader settings (Masters), memory buttons, the page and Chaser Program Numbers will be transferred, to initiate MIDI.
 - While MIDI IN is turned on or off, each internally activated Memory, the Chaser and Insert Fades will be removed.
 - When MIDI IN is turned on, the Main Master, the Preset-A and -B master will be turned to 100 %. The chaser master is set to 0 %.
- Commands:
 The Status Byte to be transferred is always the Control Change Command.
 = 1011nnnn (Bn hex) (nnnn=MIDI Channel).
 Hence, two Data bytes are following:

<u>Name:</u>	<u>1.</u>	<u>2. Data byte:</u>
Memory Fader 1	00 (102)	+00-127 (Fader level)
Memory Fader 2	01 (103)	+00-127 (Fader level)
Memory Fader X	XX (XX)	+.....
Memory Fader 12	11 (113)	+00-127 (Fader level)
Main Master Fader	17 (119)	+00-127 (Fader level)
Preset A Master	18 (120)	+00-127 (Fader level)
Preset B Master	19 (52)	+00-127 (Fader level)
Chaser Master	20 (53)	+00-127 (Fader level)
Memory button 5-8	23 (54)	+08=Mem5 04=Mem6 02=Mem7 01=Mem8
Memory button 1-4	24 (55)	+08=Mem1 04=Mem2 02=Mem3 01=Mem4
Memory button 9-12	26 (57)	+08=Mem9 04=Mem10 02=Mem11 01=Mem12
Page 0-9	27 (58)	+00-09 (Page 0 9)
Solo Function	28 (59)	+16=Channel Flash 08=Zero +04=Memory Flash 02=Preset B Flash +01=Preset A Flash
Chaser Start (+No.)	32 (63)	+00-98 (Chaser number)
Chaser Step button	33 (20)	+00-XX (value doesn't matter)
Preset Mode ON	48 (29)	+00-XX (value doesn't matter)
X-Fader	49 (30)	+00-127 (Fader level)
X-Fade Insert	50 (31)	+00 = ON, -00 = OFF (unequal zero)
X-Fade Manual	51 (84)	+00 = ON, -00 = OFF (unequal zero)
Preset Flash buttons	52 (85)	+04=Preset A 02=Preset B 01=Zero
Sound to Light Mode	53 (86)	+00 = ON, -00 = OFF (unequal zero)
Sound to Light Pause	54 (87)	+00-127 (Fader level)
Sound to Light Bass	55 (88)	+00-127 (Fader level)
Sound to Light Mid	56 (89)	+00-127 (Fader level)
Sound to Light Treble	57 (90)	+00-127 (Fader level)
Chaser Speed Fader	58 (70)	+00-127 (Fader level)
Chaser Mode	59 (71)	+00 = Sound, 01 = Run, 02 = Manual

Numbers in brackets are the values for the second controller set.

Important Button Keys

Deleting the entire stored programs	(Delete All)
Freezing the Two Presets Mode	(Lock Preset Mode)
Programming disabled	(Lock Programming)
Indicating the Chase storage	(Blank Chase Storage indication)
Indicating the Software Version	(Software Version)

These following five functions are available, if the desk is turned off and the respective buttons are pressed and held down, while turning on the desk again.



- Observe the display and hold the buttons until the menu is displayed!
-
-

Delete All



- Press and hold **Soft A + Soft B + Quit**.
 - **YES** deletes all Memories and Chasers. Presettings will be set to **Standard**.
(Patch: 1 :1; Solo: All Enabled; Curve: All Linear)
-
-

Lock Preset Mode

- Press and hold **Hold + Live + Upper**.
 - **YES** activates the Preset Mode and locks Page.
Undo: Repeat proceeding, hence press **NO**.
-

Lock Programming

- Press and hold **Memory + Chase + Utility 1**.
 - **YES** locks **Programming**, **Backup** and the function **MODIFY** available within **Preview Menu**
Undo: Repeat proceeding, hence press **NO**.
-
-

Blank Chaser Storage indication

- Press and hold **Preview + Soft A + Soft B**.
On display are the remaining steps to be programmed.
Upon release of the buttons, the desk returns to Top Menu.
-



Software Version

- Hold both Soft Buttons, while turning on the desk.
-

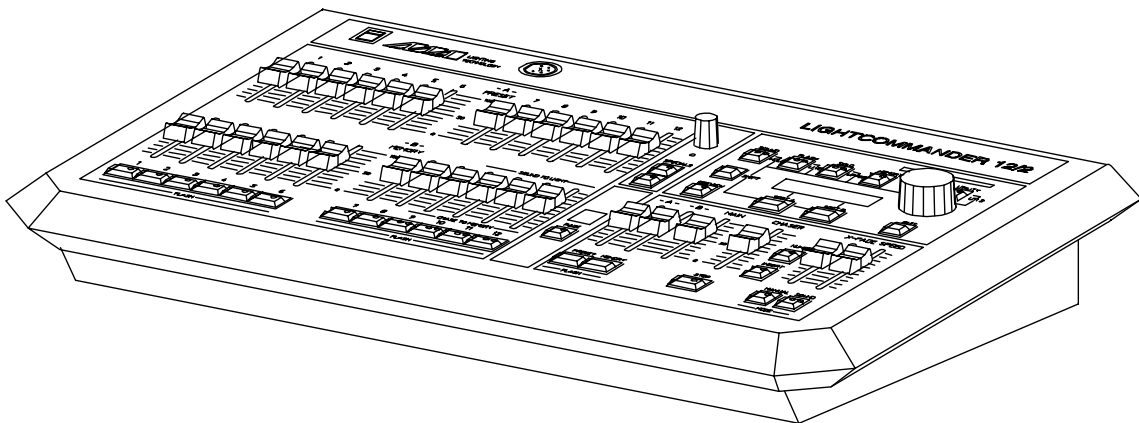
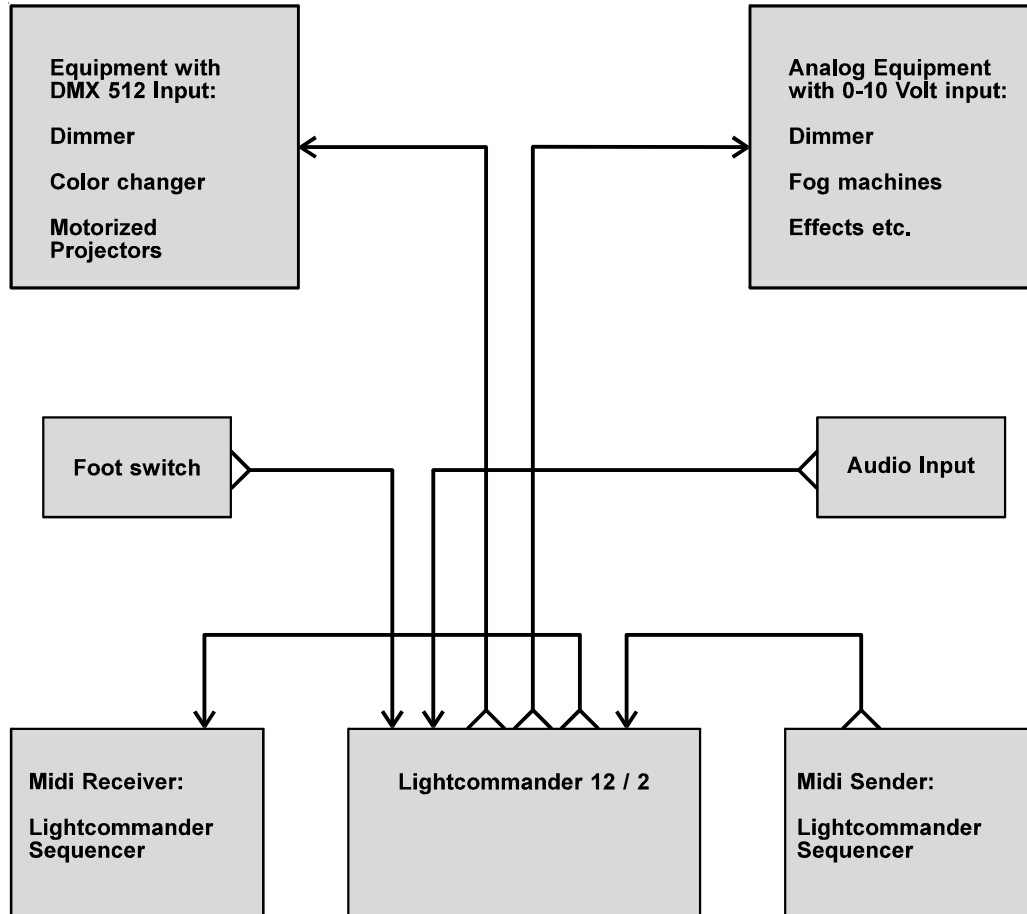

Technical Specification

Inputs and Outputs (Pinlayout)

1. Power Input:

The rated voltage is 230 V Alternating Current (50 Hz).

➔ The mains supply compensates voltage fluctuations between 180 and 240 VAC.



➔ **Attention! To meet the security standards, the desk must be operated with grounded Power outlets!**

2. Analog Output; 0-10 V positive direct current:

The control signal is output at a 15-PIN SUB-D Socket.

<u>Pinlayout:</u>	Pin 1 -12	Channel 1 -12
	Pin 13 -14	Channel S1 -S2
	Pin 15	Ground (Earth)

3. DMX Output:

The DMX Output meets USITT DMX 512 (1990) Standard.

The Lightcommander can control each equipment, meeting this standard.

<u>Pinlayout:</u>	Pin 1 = Ground	Pin 4 = not connected
	Pin 2 = Data -	Pin 5 = not connected
	Pin 3 = Data +	

4. Sound input (Sound In):

A RCA socket is used to feed an audio signal. An input transformer is used to isolate the input. Impedance approx. 1 kOhm.

➔ The input needs a minimum voltage feed of approx. 100 mV to be operative. Setting: Turn Sound input control until the LED flashes with Bass Rhythm.



5. Remote Step (Remote GO):

Use a 1/4 inch Jack, to connect a foot switch to the desk. Having contact, the Chaser proceeds one Step ahead.

6. MIDI IN / MIDI OUT:

The MIDI Interface meets M I D I Standard.

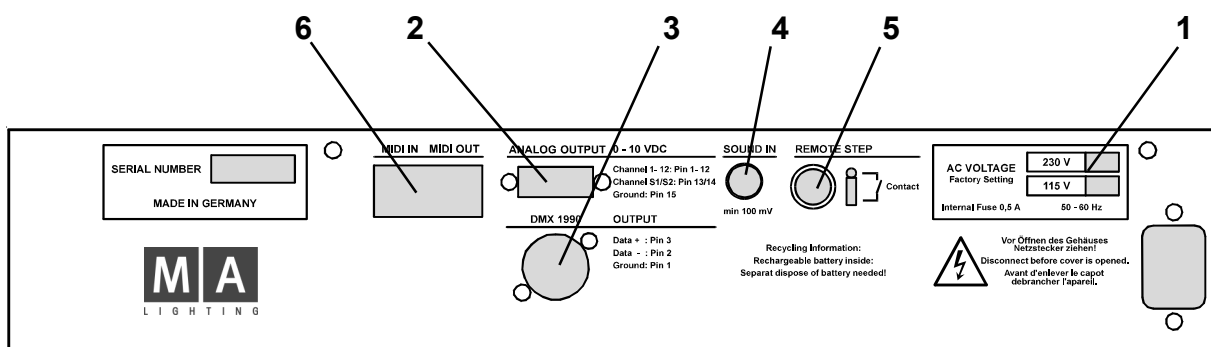

7. 3 Pin XLR Socket for a desk lamp:

<u>Pinlayout:</u>	Pin 1 = not connected
	Pin 2 = Ground
	Pin 3 = 12 VDC

➔ **Note: Subject to change without notice.**

Safety Instructions:

1. Read all the instructions in the user's manual.
2. Keep the user's manual for later use.
3. Follow all the instructions on the unit.
4. Pull the plug before cleaning the unit; don't use any liquid or spray cleaner. Clean with a damp cloth.
5. Don't use the unit near water.
6. Don't put the unit on unstable tables etc.. It might fall down and get damaged.
7. There are slots in the case for aeration; don't cover these slots up because they guarantee the reliable use of the unit and protect it against overheating. Don't install the unit into a frame unless sufficient aeration is guaranteed.
8. The unit is provided with a safety plug. This plug can only be used with safety sockets. These safety measures should by all means be followed. In case the plug doesn't fit into the socket (e.g. with old sockets), the socket should be replaced by an electrician.
9. Don't put any objects on the wire and make sure nobody steps on it.
10. In case you use an extension wire make sure the sum of the power consumption of the connected units does not exceed the maximum power of the wire. The sum of the units plugged in the socket should not exceed 10 Ampere.
11. Don't spill any liquid over the unit. Don't put any objects through the slots of the unit, as these might get in contact with parts that are live or might cause short circuits. This may cause fires and shocks.
12. Don't service the unit yourself as parts that are live might be exposed when you open the case; you run the risk of getting shocked. All services should only be carried out by a specialist.
13. If one of the following conditions occurs, please pull the plug out and call the service:
 - A. Wire or plug is damaged or worn.
 - B. Liquid got into the unit.
 - C. The unit was exposed to rain or got damp.
 - D. The unit doesn't work properly even if you follow the instructions of the user's manual.
 - E. The unit fell down and the case was damaged.
14. Only use wires which are marked safety proof.
15. Don't use any high-power walkie-talkies near the unit.

DECLARATION OF CONFORMITY

according to guide lines 89/336 EWG and 92/31 EWG:

Name of producer: MA Lighting Technology GmbH
Address of producer: Dachdeckerstr. 16 D-97297 Waldbüttelbrunn

declares that the product

Name of product: MA Lightcommander 12/2
Type: LC 12/2

answers the following product specifications:

Safety: EN60065, VDE0860, IEC65
EMV (EMC): EN55103-1 (E1), EN50081-1
EN55103-2 (E2), EN50082-1

Additional information: All DMX512 and analogue inputs and outputs must be shielded and the shielding must be connected to the ground and the case of the corresponding plug.

Waldbüttelbrunn, 17.01.1995



Dipl. Ing. Michael Adenau

INDEX

A

- Advanced Chase Operation 16
- Advanced Chase Playback 14
 - Insert-Mode 14
 - Inserting Memories 14
 - Manual Crossfade 14
 - Manual Step / GO 14

B

- Backup 18
- Blind 20

C

- Channel Presettings 23
- Channel-Flash 8, 9
- Chase 15
 - Chase Program 12
 - NEW CHASE? 12
 - Number 12
- Chase Steps 15
 - Editing Level Steps 15
 - Editing Memory Steps 15
 - Inserting Level Steps 15
 - Inserting Memory Steps 15
 - Programming steps blind 15
- Chase to Memory 16
 - Chase to Memory Playback 16
 - Preview Chase to Memory 16
 - Programming Chase to Memory 16
- Chaser Operation 12
 - Mode 13
- Chaser Playback 13
 - Auto-Speed 13
 - Run-Mode 13
 - Sound Mode 13
 - X-Fade Time 13
- Chaser Section 13
- CONNECT 23
- Connecting Desk-Channels to DMX-Channels 23

D

- Data Storage on Memory Card 18
- Dipless Crossfade 11
- Disable Solo 24
- DMX-Patch 23
 - Connecting Desk-Channels with DMX-Channels 23
 - DMX-Assignment 23
 - Introduction 23

E

- Editing a Memory 11
- Editing Steps 15

F

- Flash Buttons 8
- Freezing the Output (Hold) 20

G

- General Functions 17
- Grab Release 22

H

- Hold 20

I

- Important Button Keys 27
- Insert-Mode 11, 14
- Inserting Memories 14
- Inserting Steps 15

L

- Level-Chase 12
- Linking 25
- Live 20
- Live / Blind Operation 20

M

- Master-Section 7
- Memory Operation 10
 - Dipless Crossfade 11
 - Editing a Memory 11
 - Insert-Mode 11
 - Memory-X-Fade 11
 - Previewing a Memory 11
- Memory Playback 10
- Memory-Card 18
 - Backup 18
 - Exchanging the Battery 18
 - Save and Load 18
- Memory-Chase 12
- Memory-Flash 10
- MIDI Operation 25
 - Introduction 25
 - Linking two Lightcommander 25
 - MIDI Format and MIDI Commands 26
 - MIDI-Show with Sequencer 25
 - Recording to a Sequencer 25
- Modify Chase 15

O

- OPEN 23
- Operating 24 Channels 22
- Operating Preset-A- 8
- Operating two Presets 9
 - Channel-Flash 9
 - Fading between Scenes 9
 - Preset-Mode 9
 - select -P- 9
 - Solo-Flash 9

P

- Page 10
- Preset Operation 8
- Presets only 9
- Preview 11
- Preview Chase to Memory 16
- Previewing a Memory 11
- Programming Chase-Steps 12
 - Level-Chase 12
 - Memories as Step 12
 - Memory-Chase 12
 - Preset as Step 12
- Programming Memories blind 11
- Programming steps blind 15
- Programming the Memory 10
 - Memory-Mode 10
 - Programming Memory 10
 - Save All 10
 - Save PRESET 10
 - select a Page 10

R

- Remote Step / GO 17

S

- Save and Load 18
- Scene Playback 14
- Select Curve 24
- Setting up the Output 23
- Settings for Analog- and DMX-Output 24
 - Disable Solo 24
 - Select Curve 24
- Shift-Functions 19
- Solo 8, 9, 10
- Sound to Light 17
 - Introduction 17
 - Operating Sound-to-Light 17
 - Prompt Program-Change 17
- Specials 1/2 18
- Stopping a Chase 13
- Survey of Shift-Functions 19
- Switch-Channels 18
 - Introduction 18
 - Switch Position 18

T

- Technical Specification 29
 - Inputs and Outputs 29
 - Pinlayout 29
 - XLR-Socket for a desk lamp 29
- Theatre Mode 21

U

- Upper Channels 22
- Using Flash Buttons 8
 - Channel-Flash 8
 - Master-A-Flash 8
 - Master-B-Flash 8
 - Memory-Flash 8
 - Solo 8
- Using Manual Masters 10
- Utility 1 23
- Utility 2 24

W

- Wide Mode 22
 - Cancelling the setting 22
 - Grab Release 22
 - Setting up the 24-Channel-Preset 22
 - Using Upper Channels 22

X

- X-Fade 13



Lightcommmander 12/2

User's Manual

Version 1.32

CE